

WOODMASTER PICTURE FRAMES

One of the best things about owning a Woodmaster is the ability to create your own unique (and profitable) custom picture frames. IT'S EASY with the wide selection of patterns now offered by Woodmaster... Forty-six popular styles and sizes to fit most any requirement. In addition, we can custom manufacture knives to match those antique picture frames. You can even design Your Very Own pattern and we will manufacture a knife just for you.

Picture yourself in the profitable business of molding picture frames... for the frame shops in your area, for your neighbors, for artists, for your family and friends, and even for yourself. You can do it... and most important... **YOU CAN DO IT FOR PROFIT!**

It's fun to make money while you enjoy yourself, it's satisfying to take pride in your craftsmanship and at the same time... show a profit. Owning a "Woodmaster Planer/Molder will give you this opportunity. We have many Woodmaster owners who are doing it right now... Why shouldn't you be one of them?

PROFILES SHOWN ARE ACTUAL SIZE

The rabbet cut on the back side of the frames provides space for glass and backing. The rabbet cuts illustrated in these profiles are only suggestions. You may wish to vary the depths and widths of these cuts in order to satisfy your own or your customer's specific needs. We suggest our stepped rabbet knife #CK387 S2. This single knife will give you the ability to machine a rabbet up to 1" wide from 1/8" 5/8" deep in your picture frames. Rabbet knives can also be custom made to suit your requirements - phone for pricing.

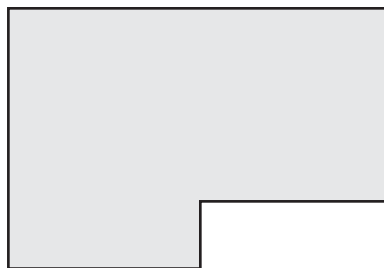

CK387 S2

Woodmaster Picture Frame Molding Profiles

All profiles shown in full perspective. You see exactly what each pattern looks like in finished form. Plus, plenty of helpful tips on the best ways to produce molding.

All pattern knives are made from industry-standard, 5/16" High-Speed, M-2 Steel.

THIS BOOK -

Use this book to choose from the widest selection of picture frame molding knives available anywhere. In addition to these profiles, Woodmaster also specializes in custom knives for antique reproductions, restoration projects and specialty products.

ORDERING IS EASY -

You can place your order by phone or fax. We accept Visa, MasterCard, American Express and Discover. Our knowledgeable staff can help you find the most efficient and economical way to produce the moldings you want. Custom knives can be made on short notice and are priced by the inch. Simply send us a scale drawing or sample of the pattern you want. (see the enclosed price sheet or call us for a quote) Phone 1-800-821-6651 Fax 1-816-920-6041

5/16" STEEL - INDUSTRY STANDARD

Woodmaster profile knives are manufactured from 5/16" thick, M-2, High Speed Tool Steel. This thickness and hardness is the industry standard established to minimize danger from breakage. Use of profile knives less than 5/16" thick can not only result in serious injury, it also voids the Woodmaster warranty.

CARBIDE KNIVES -

These are a **must** for MDF moldings. Woodmaster can furnish carbide knives in nearly all profiles for Woodmaster, RBI, Belsaw and Williams & Hussey planer/molders. Call for quote at 1-800-821-6651.

CHOOSING THE CORRECT KNIFE -

With Woodmaster's variable feed rate, you can produce most moldings with a single knife place in the 700C Holder or the Planer Head, depending on the width of the knife. Knives up to 3-1/4" can be used either in the 700C Knife Holder or the Planer Head. **Knives wider than 3-1/4" must be used only in the Planer Head.** Larger patterns involving a substantial amount of wood removal (log cabin siding, for example) will require a matched set of three knives placed in the planer head. So that we can send you the proper balance weights for each type of knife you order, please specify the kind of planer you have and whether you will be using the knife in the 700C Knife Holder or the Planer Head.

KNIVES FOR OTHER MACHINES -

Woodmaster can also make knives to fit molders from Belsaw, RBI, Grizzly and Jet. Knife heights and balance weights will differ, so please specify which machine you will be using.

CURVED MOLDING -

It's easy to make high-profit curved molding on your Woodmaster. Our video on this subject gives detailed, step-by-step instructions. (Call to order @ \$29.95). If you are making curved molding, please let us know. This is because profile knives for curved casing and baseboard are made without the parting legs used for straight molding.

Woodmaster Picture Frame Patterns

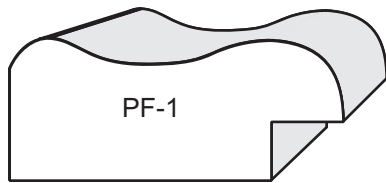

PF-1

3/4" x 1-3/4"

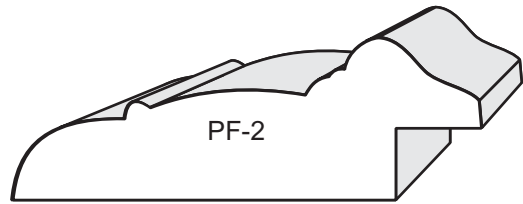

PF-2

7/8" x 2-7/16"

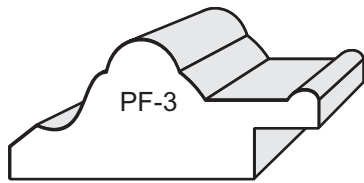

PF-3

3/4" x 1-5/8"

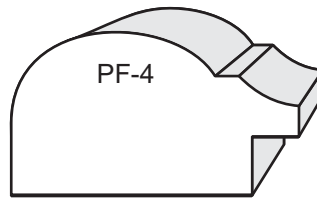

PF-4

1-3/16" x 1-1/2"

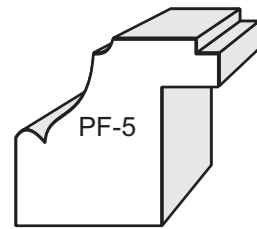

PF-5

1" x 1-1/16"

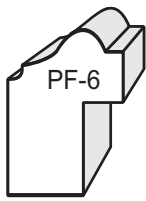

PF-6

7/8" x 5/8"

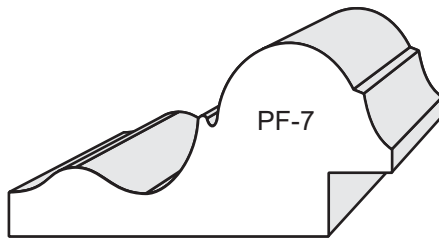

PF-7

1" x 2"

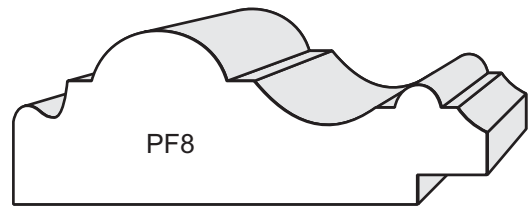

PF8

15/16" x 2-9/16"

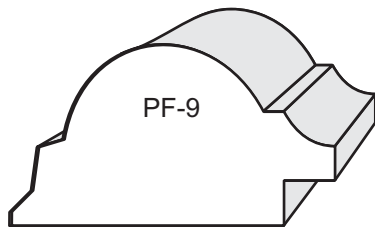

PF-9

15/16" x 1-11/16"

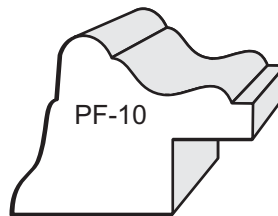

PF-10

15/16" x 1-1/4"

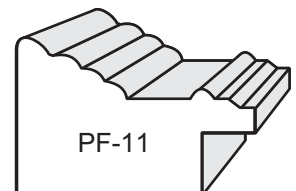

PF-11

13/16" x 1-1/4"

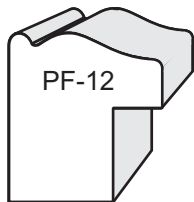

PF-12

7/8" x 13/16"

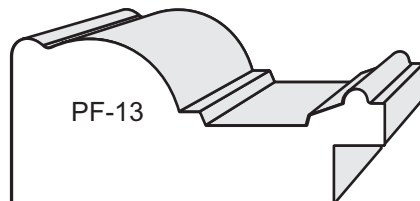

PF-13

7/8" x 1-15/16"

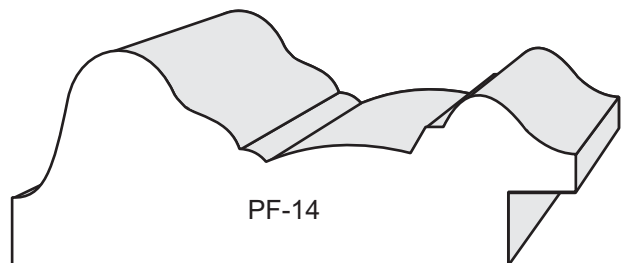

PF-14

1-1/8" x 2-15/16"

Woodmaster Picture Frame Patterns

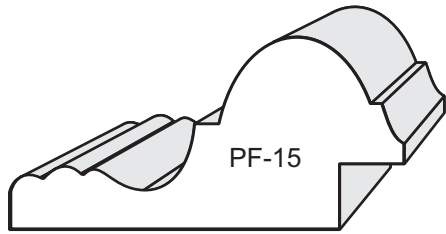

PF-15

1 x 2-1/16"

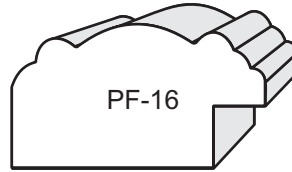

PF-16

3/4" x 1-5/16"

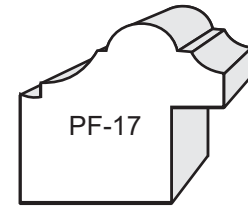

PF-17

15/16" x 1-1/16"

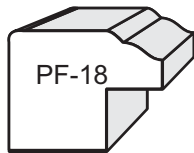

PF-18

5/8" x 13/16"

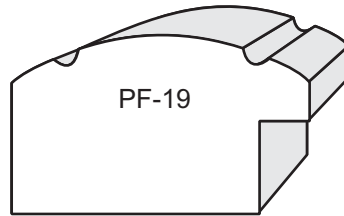

PF-19

15/16" x 1-9/16"

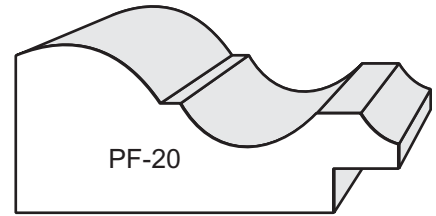

PF-20

7/8" x 2"

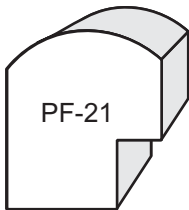

PF-21

15/16" x 13/16"

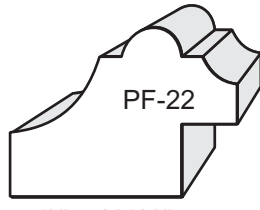

PF-22

7/8" x 13/16"

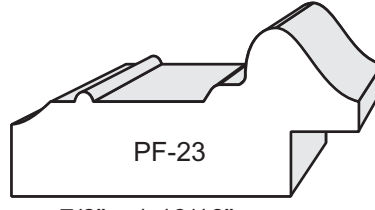

PF-23

7/8" x 1-13/16"

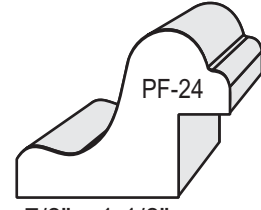

PF-24

7/8" x 1-1/8"

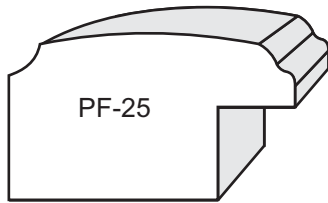

PF-25

7/8" x 1-1/2"

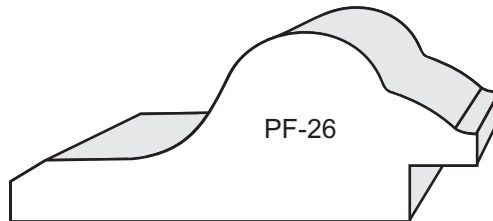

PF-26

1" x 2-7/16"

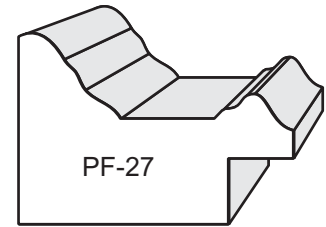

PF-27

1" x 1-7/16"

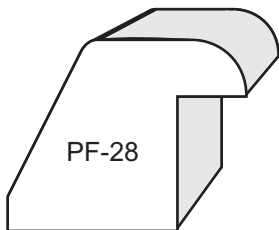

PF-28

1" x 1-1/4"

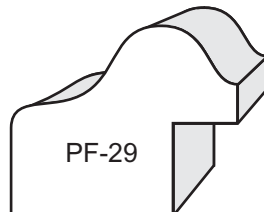

PF-29

1" x 13/16"

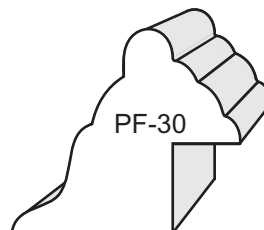

PF-30

1-1/16" x 1-1/16"

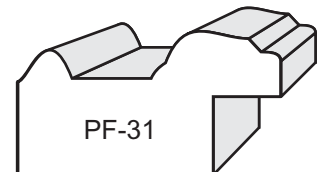

PF-31

3/4" x 1-3/8"

Woodmaster Picture Frame Patterns

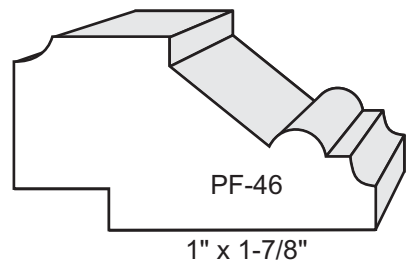
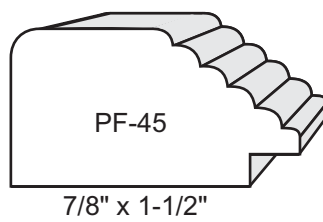
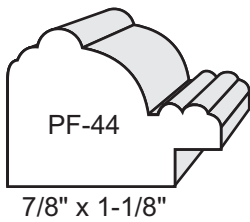
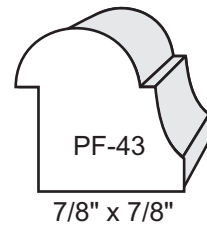
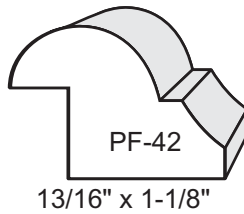
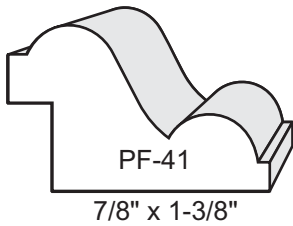
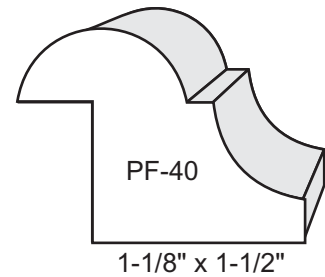
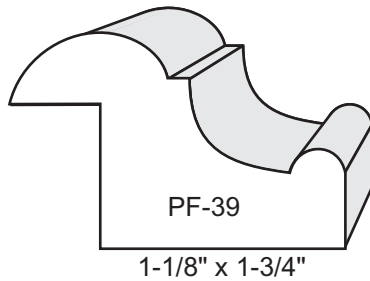
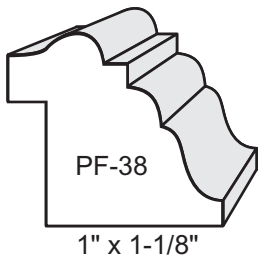
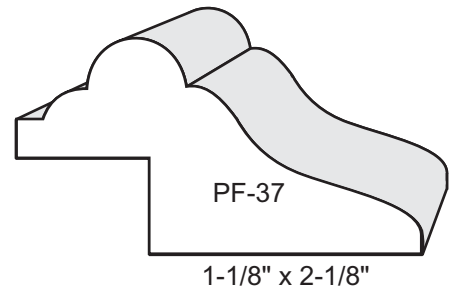
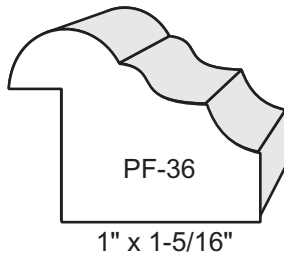
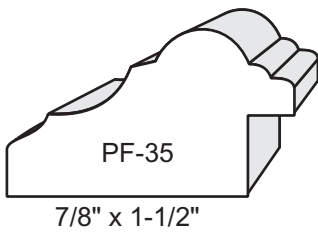
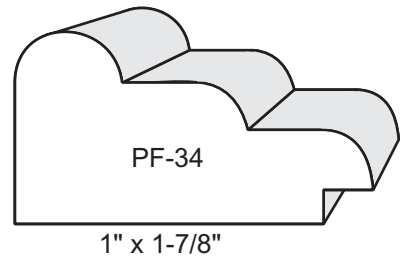
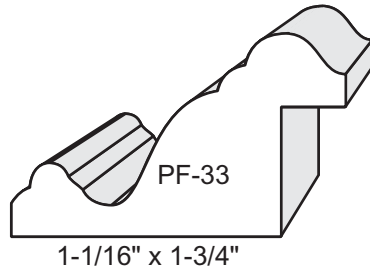
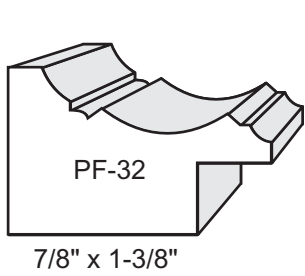

Woodmaster Picture Frame Patterns

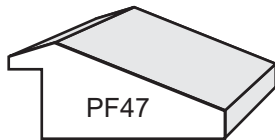

PF47
1/2" x 1-1/8"

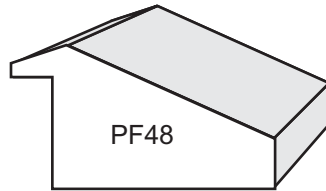

PF48
3/4" x 1-3/8"

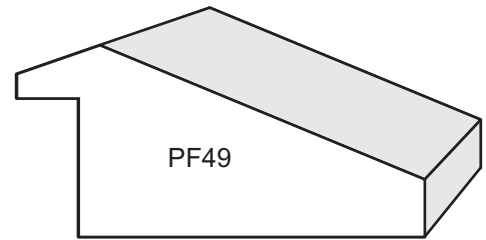

PF49
1" x 2-1/8"

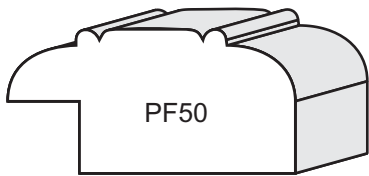

PF50
3/4" x 1-1/2"

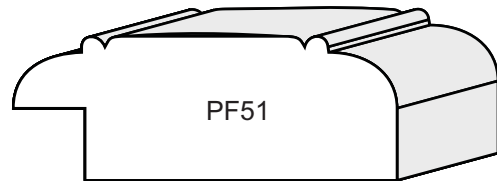

PF51
3/4" x 2"

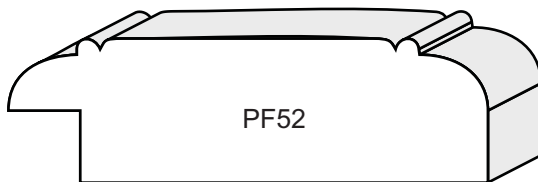

PF52
3/4" x 2-1/2"

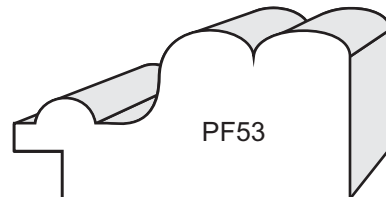

PF53
7/8" x 1-3/4"

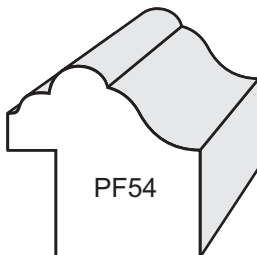

PF54
1" x 1"

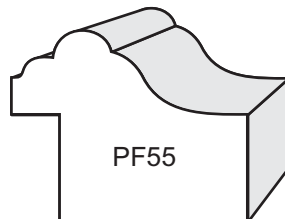

PF55
1" x 1-1/4"

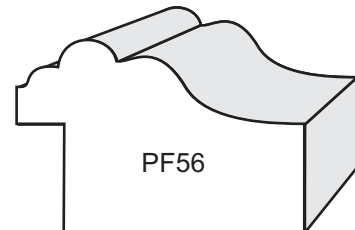

PF56
1" x 1-1/2"

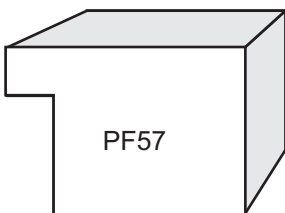

PF57
7/8" x 1-1/4"

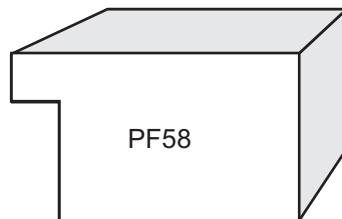

PF58
7/8" x 1-1/2"

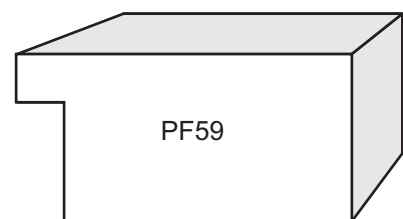

PF59
7/8" x 1-3/4"

Woodmaster Picture Frame Patterns

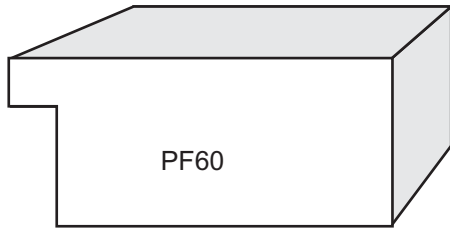

7/8" x 2"

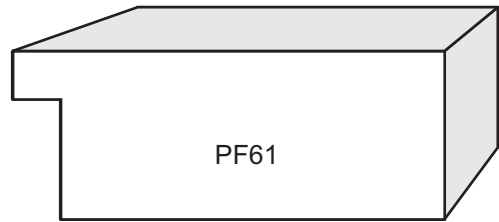

7/8" x 2-1/4"

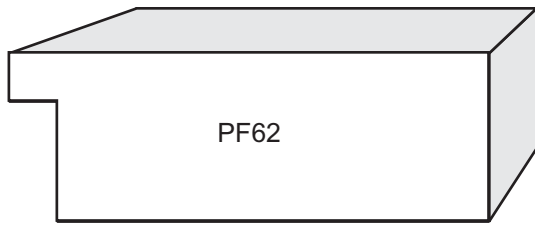

7/8" x 2-1/2"

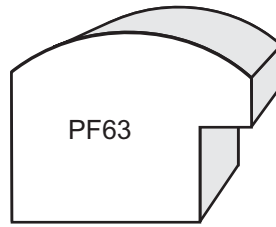

1" x 1-1/4"

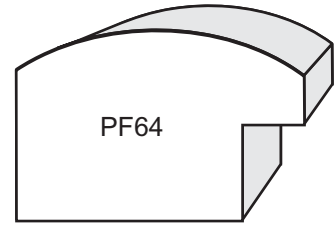

1" x 1-1/2"

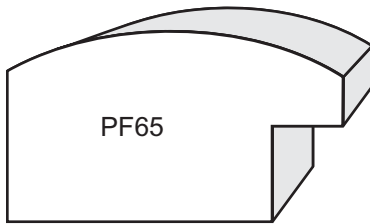

1" x 1-3/4"



1" x 2"

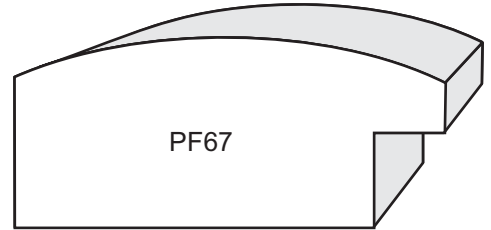

1" x 2-1/4"

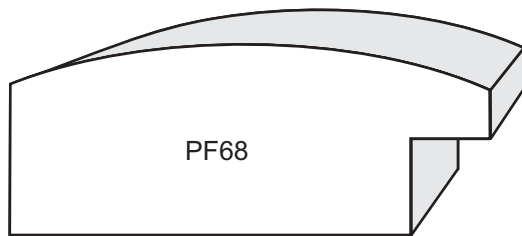

1" x 2-1/2"

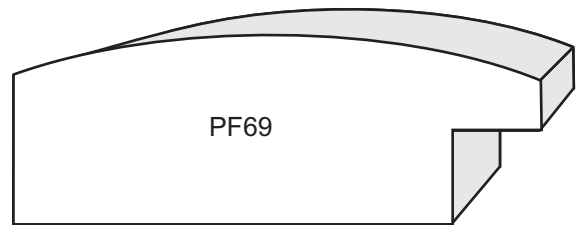

1" x 2-3/4"

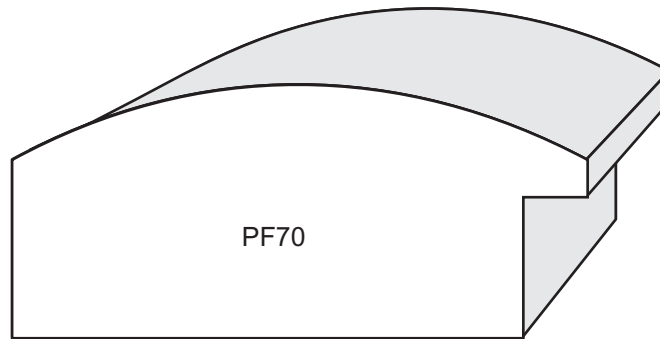

1-1/4" x 3"

Woodmaster Picture Frame Patterns

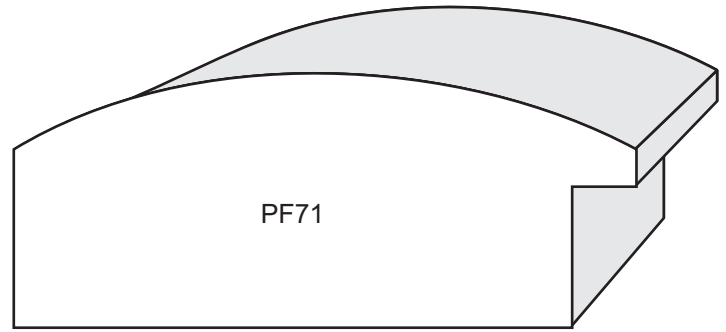

1-15/16" x 3-1/4"

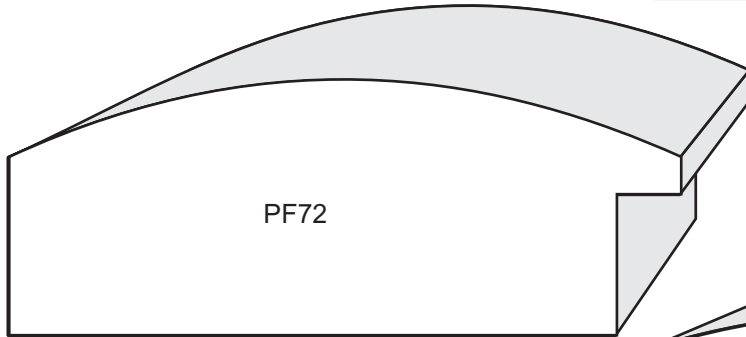

1-5/16" x 3-1/2"

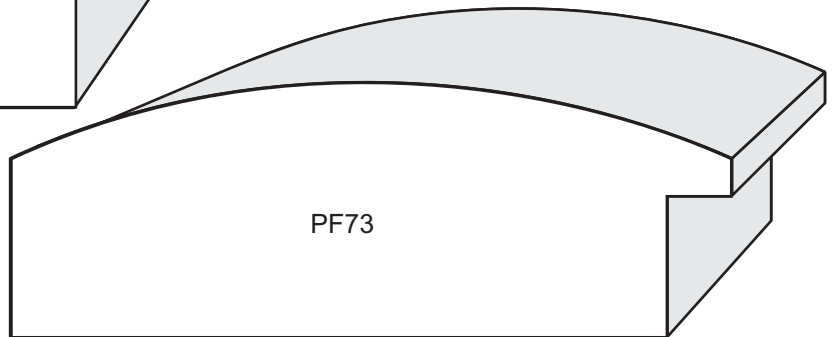

1-5/16" x 3-3/4"

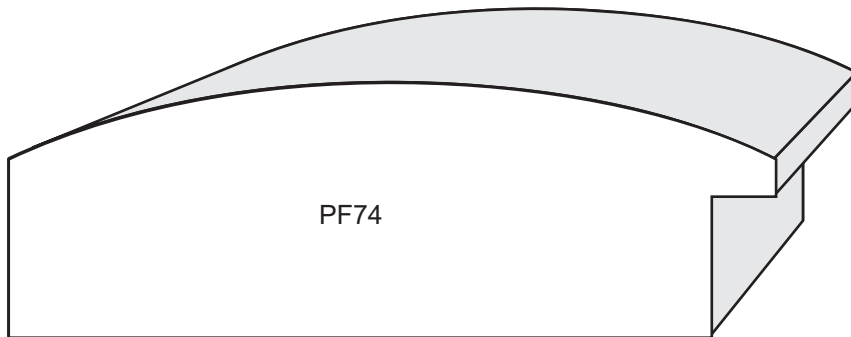

1-5/16" x 4"

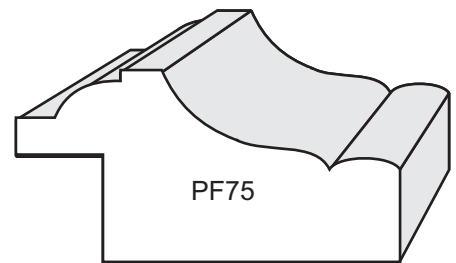

1" x 2"

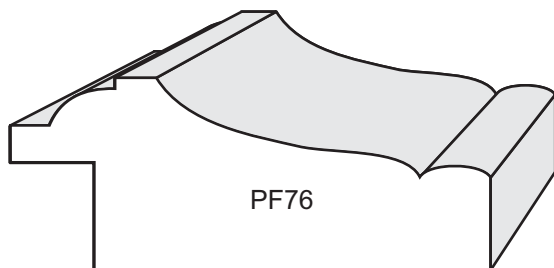

1" x 2-1/2"

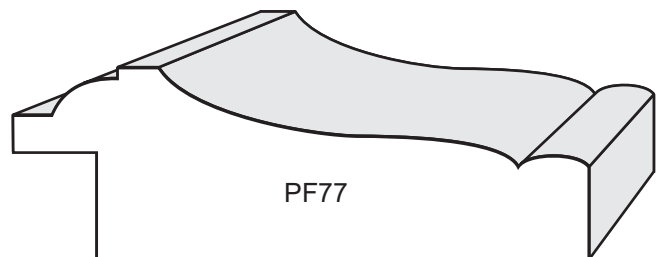

1" x 3"

Woodmaster Picture Frame Patterns

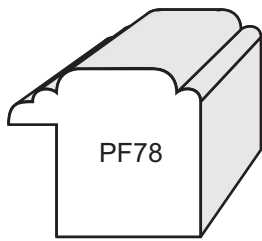

PF78

7/8" x 1"

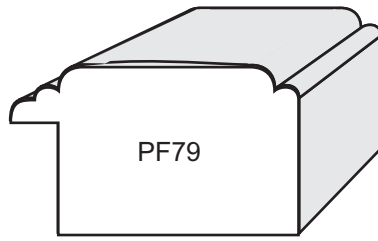

PF79

7/8" x 1-1/2"

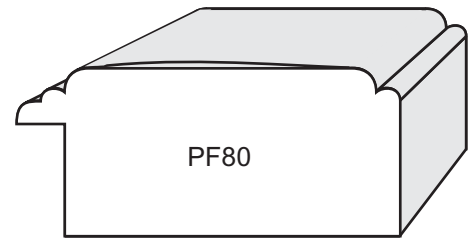

PF80

7/8" x 2"

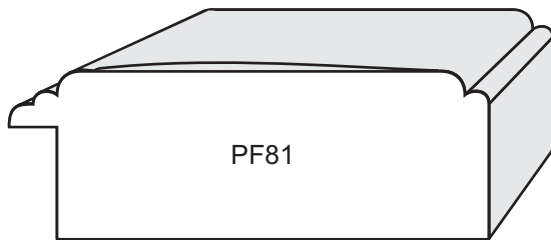

PF81

7/8" x 2-1/2"

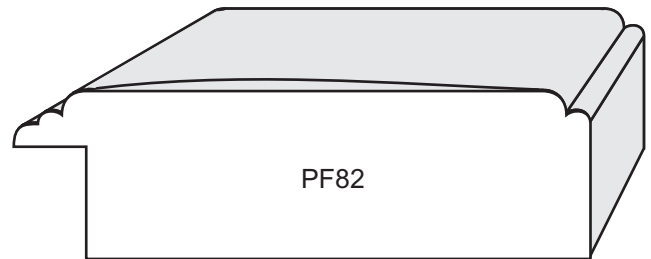

PF82

7/8" x 3"

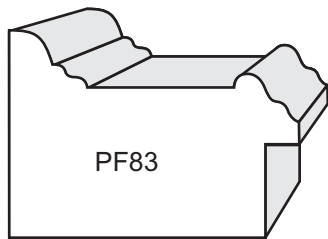

PF83

1-1/16" x 1-1/2"

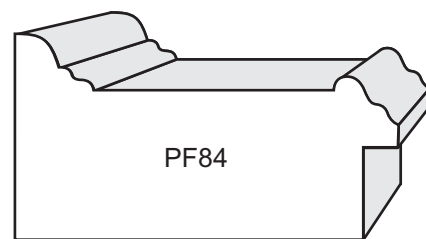

PF84

1-1/16" x 2"

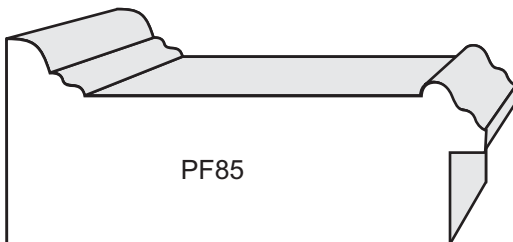

PF85

1-1/16" x 2-1/2"

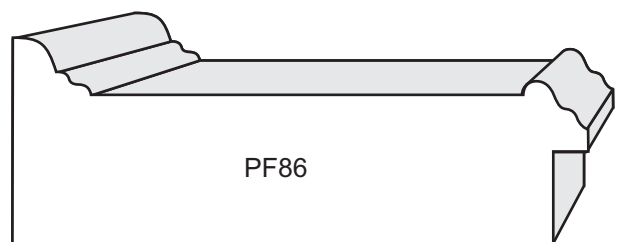

PF86

1-1/16" x 3"

Woodmaster Picture Frame Patterns

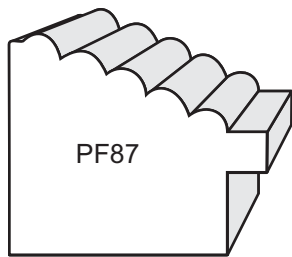

PF87

1-1/8" x 1-3/8"

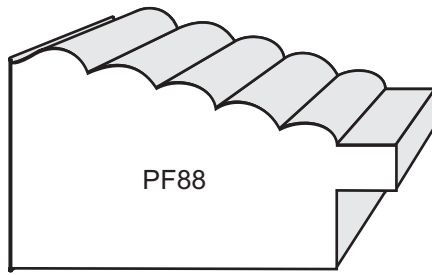

PF88

1-3/16" x 2"

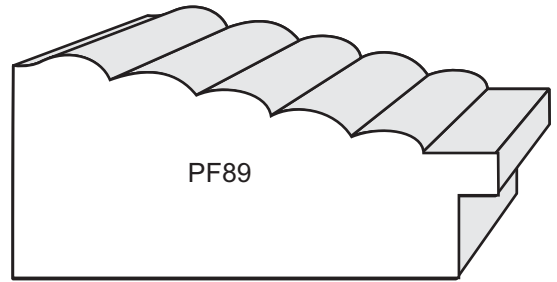

PF89

1-3/16" X 2-1/2"

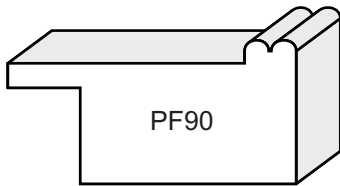

PF90

3/4" x 1-1/2"

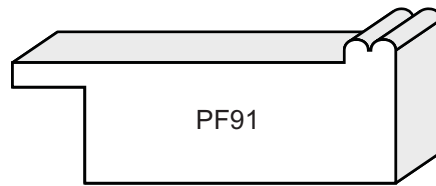

PF91

3/4" x 2"

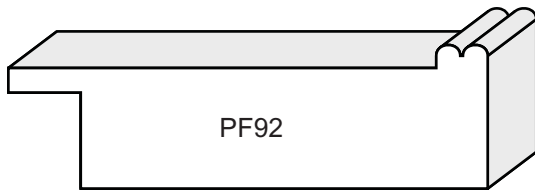

PF92

3/4" x 2-1/2"

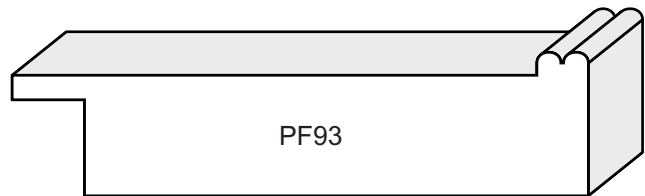

PF93

3/4" x 3"

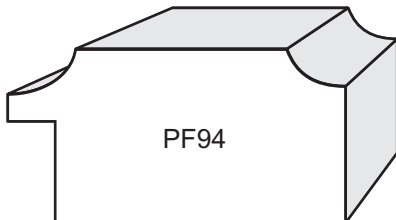

PF94

7/8" x 1-3/4"

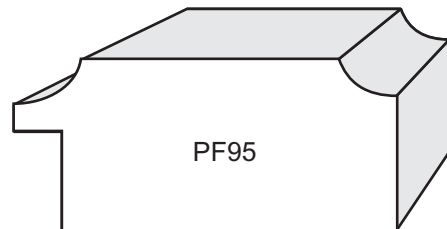

PF95

7/8" x 2"

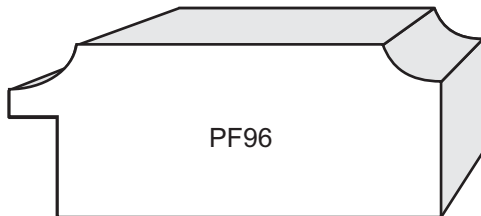

PF96

7/8" x 2-1/4"

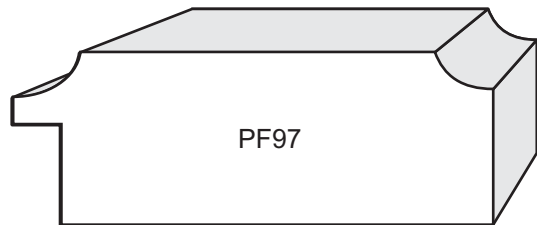

PF97

7/8" x 2-1/2"

Woodmaster Picture Frame Patterns

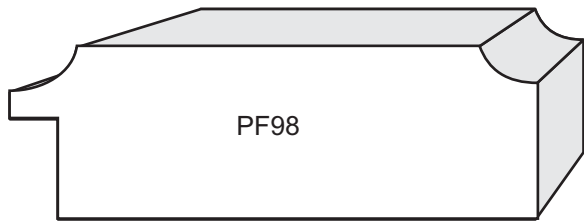

PF98

7/8" x 2-3/4"

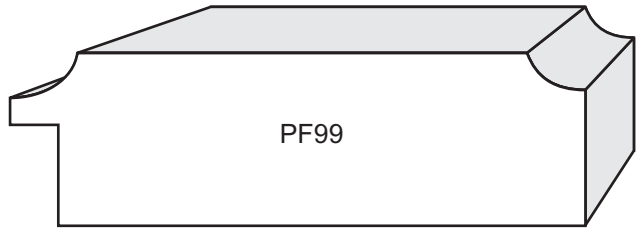

PF99

7/8" x 3"

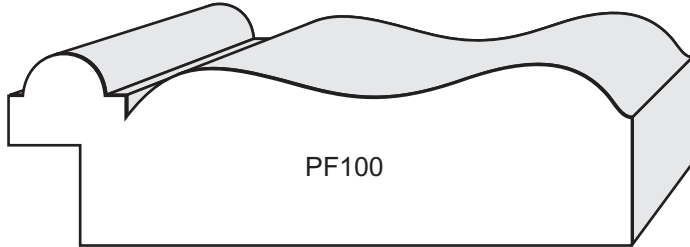

PF100

1" x 3-1/4"

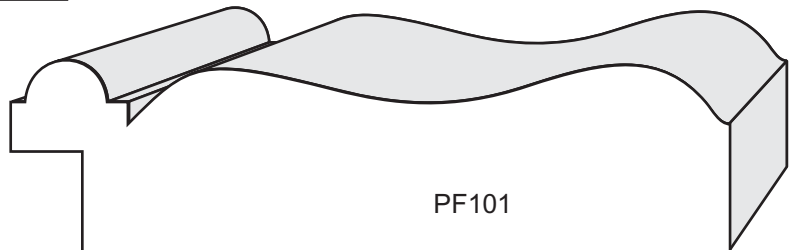

PF101

1" x 3-3/4"

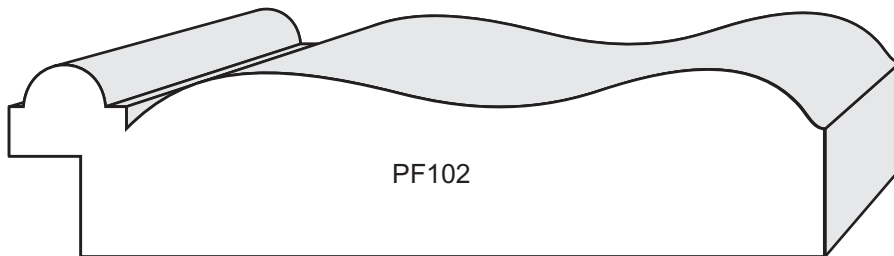

PF102

1" x 4-1/4"

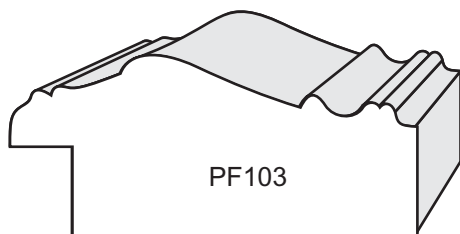

PF103

15/16" x 2-1/8"

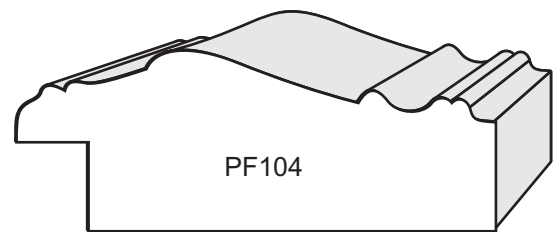

PF104

15/16" x 2-1/2"

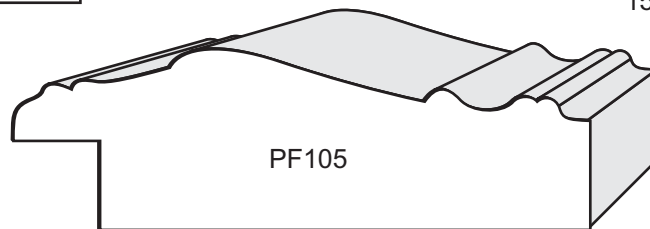

PF105

15/16" x 3"

Woodmaster Picture Frame Patterns

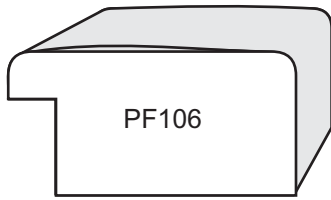

PF106

3/4" x 1-1/2"

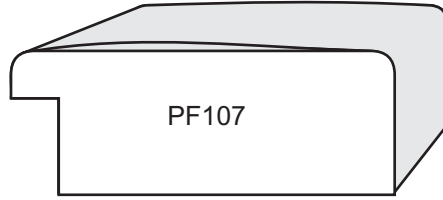

PF107

3/4" x 2"

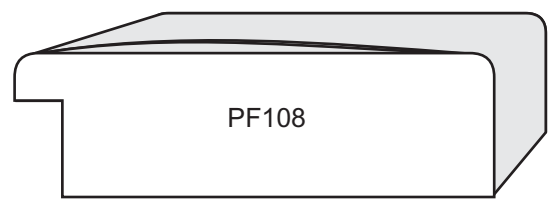

PF108

3/4" x 2-1/2"

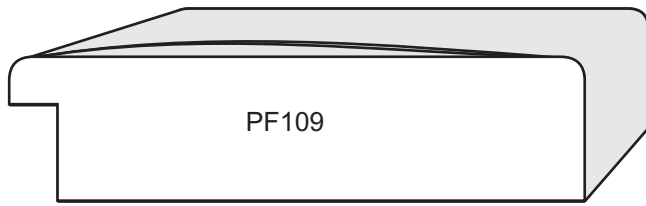

PF109

3/4" x 3"

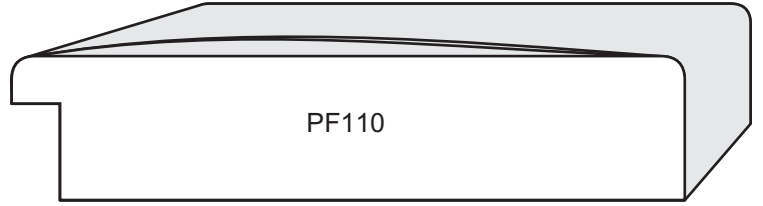

PF110

3/4" x 3-1/2"

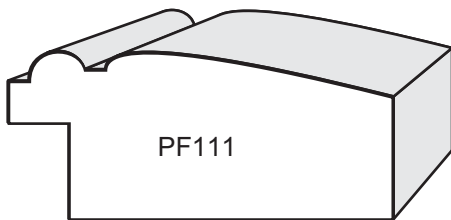

PF111

7/8" x 2"

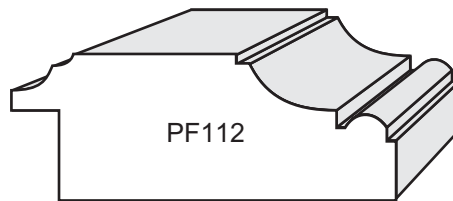

PF112

3/4" x 2"

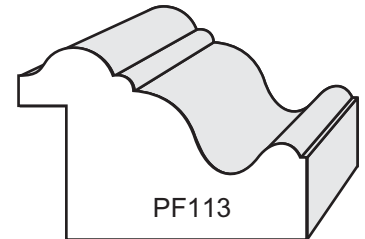

PF113

1" x 1-1/2"

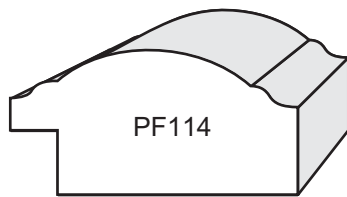

PF114

3/4" x 1-1/2"

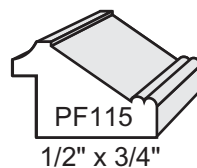

PF115

1/2" x 3/4"

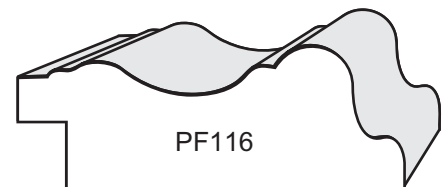

PF116

3/4" x 2"

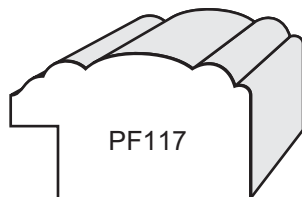

PF117

3/4" x 1-1/4"

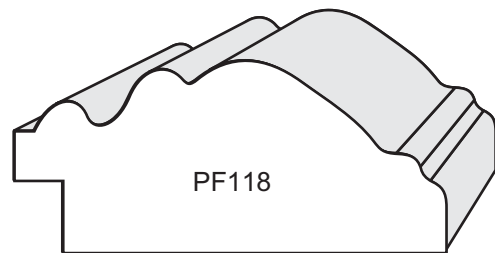

PF118

1" x 2-1/4"

Woodmaster Picture Frame Patterns

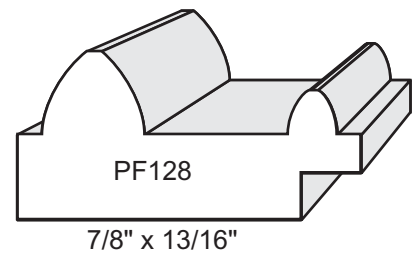
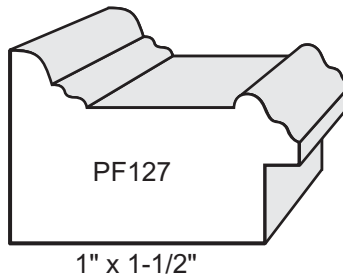
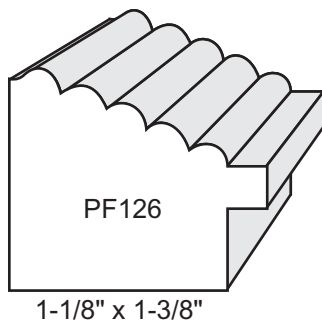
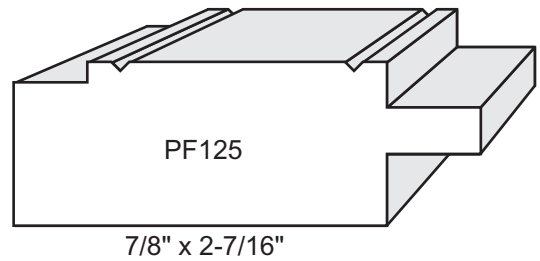
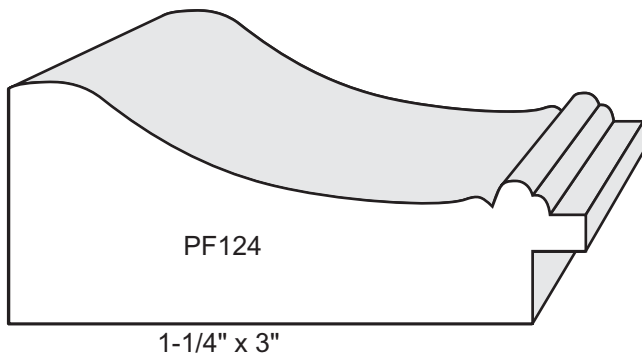
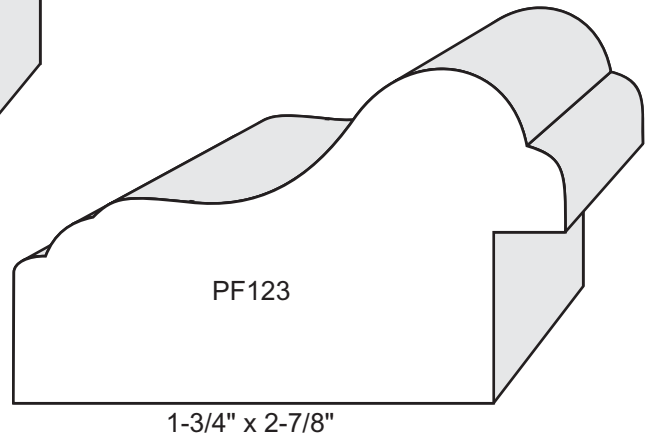
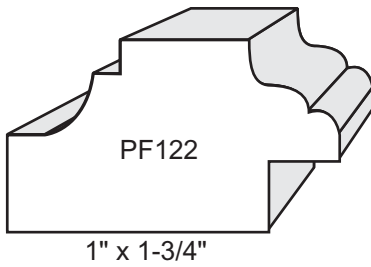
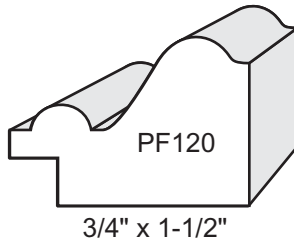
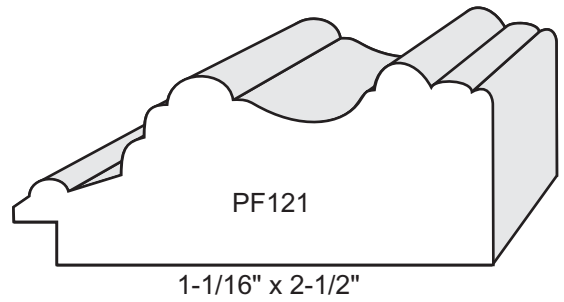
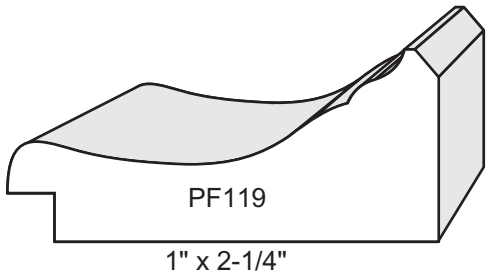

Woodmaster Picture Frame Patterns

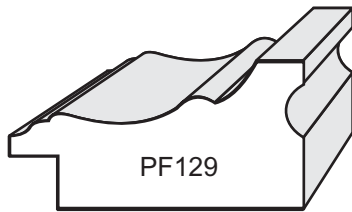

PF129

3/4" x 1-1/2"
(2 Knives)

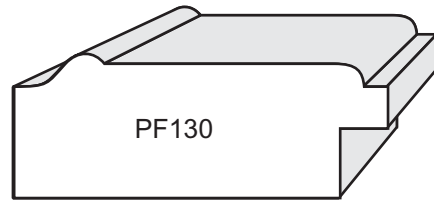

PF130

3/4" x 1-15/16"

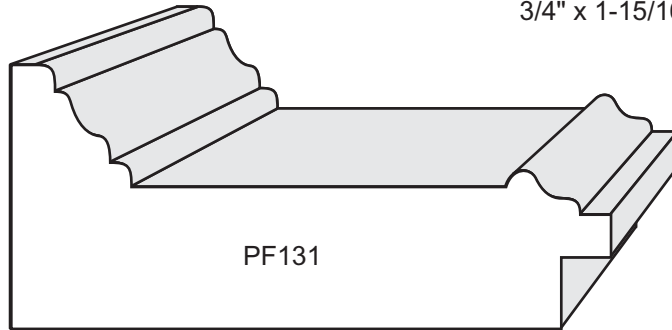

PF131

1-3/8" x 3-1/8"

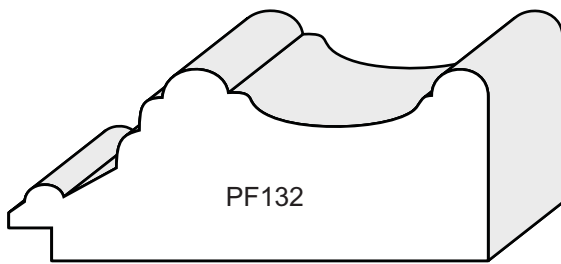

PF132

1" x 2-1/2"

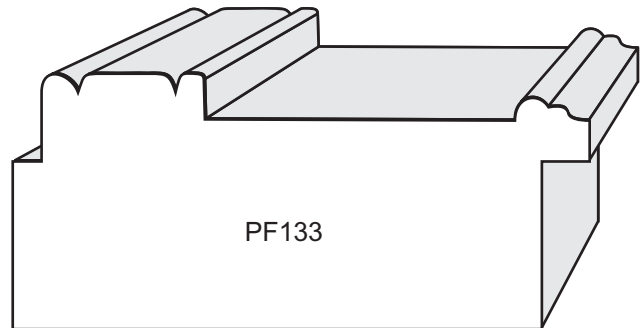

PF133

1-5/16" x 3"

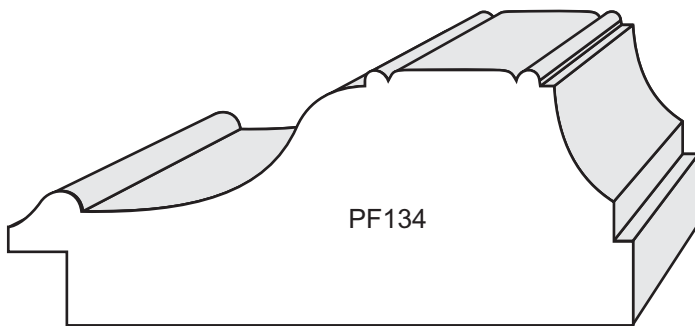

PF134

1-5/16" x 3-1/4"

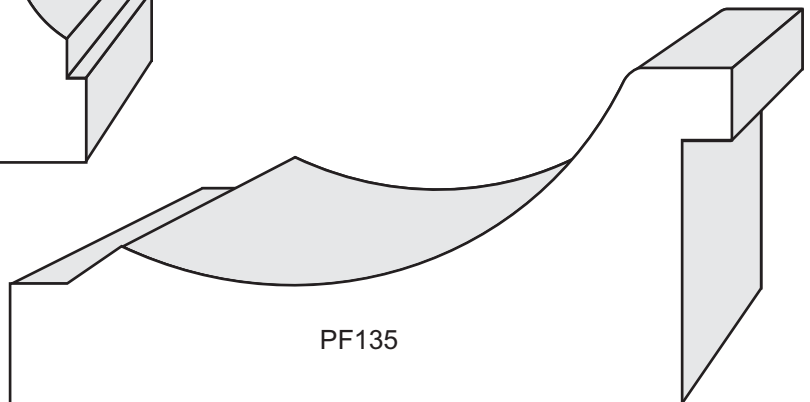

PF135

1-3/4" x 3-3/4"

Woodmaster Picture Frame Patterns

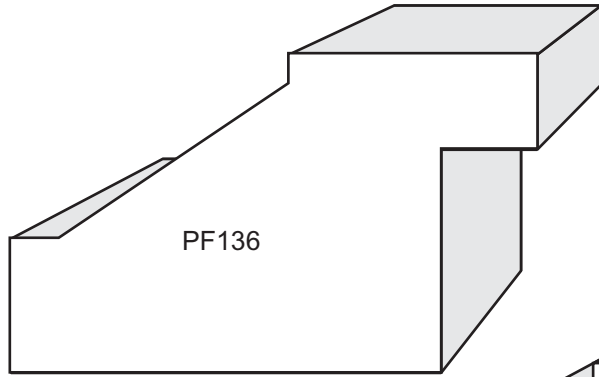

PF136

1-11/16" x 2-3/4"

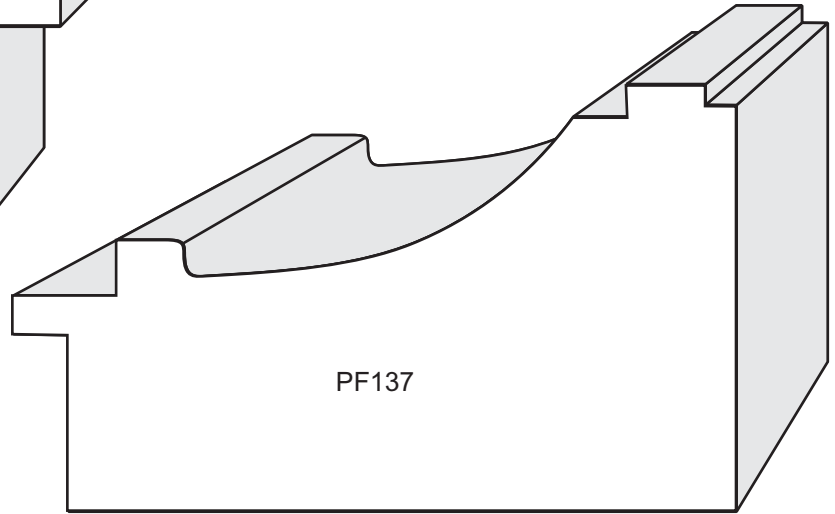

PF137

2-1/4" x 3-3/4"

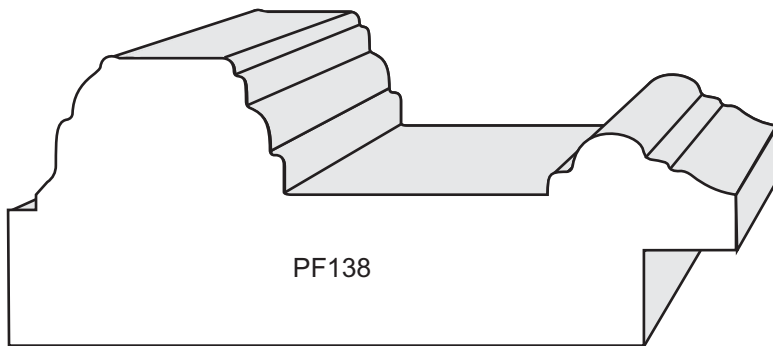

PF138

1-1/2" x 3-3/4"

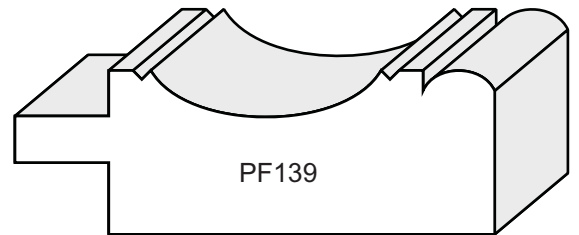

PF139

7/8" x 2-1/2"

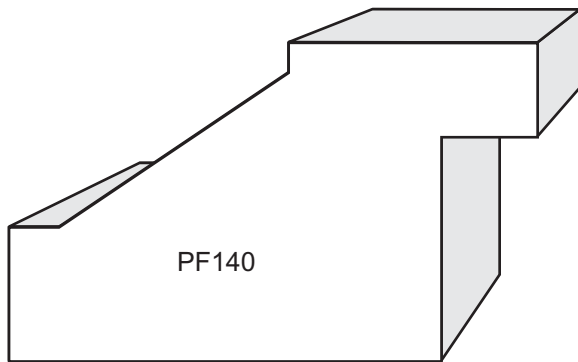

PF140

1-11/16" x 2-3/4"

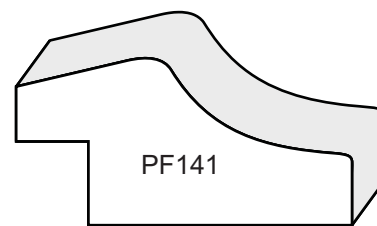

PF141

7/8" x 1-3/4"

Woodmaster Picture Frame Patterns

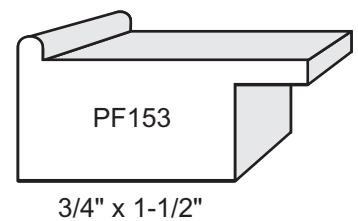
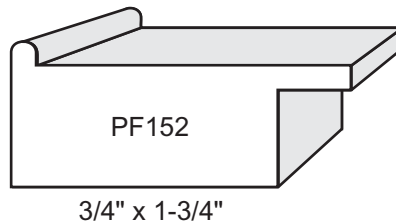
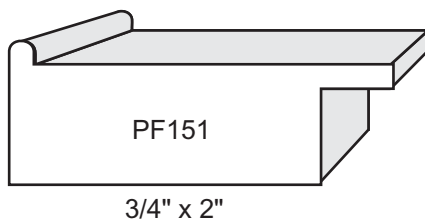
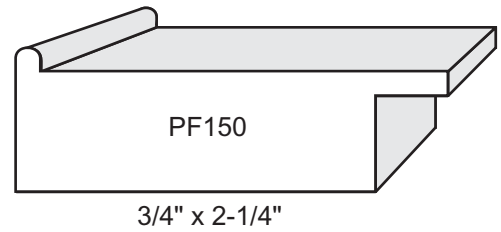
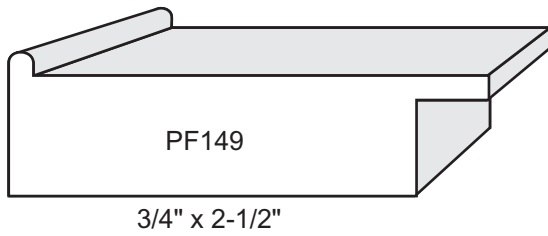
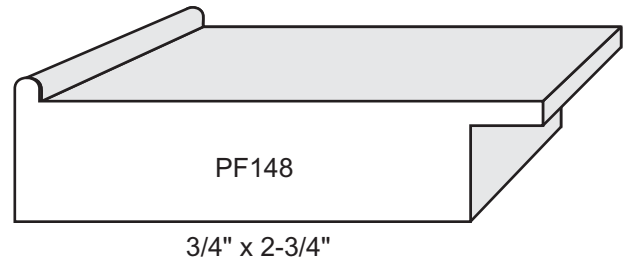
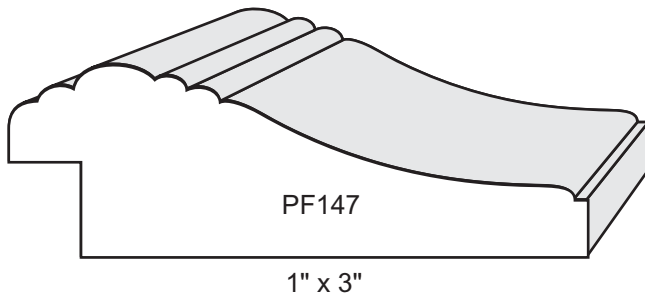
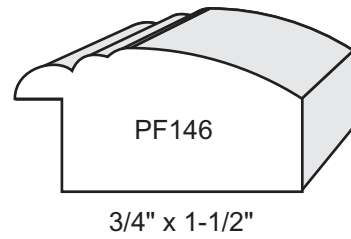
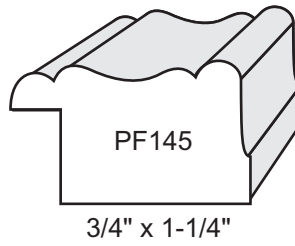
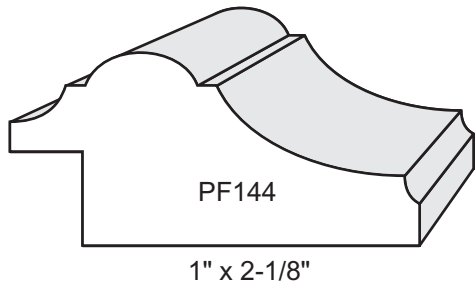
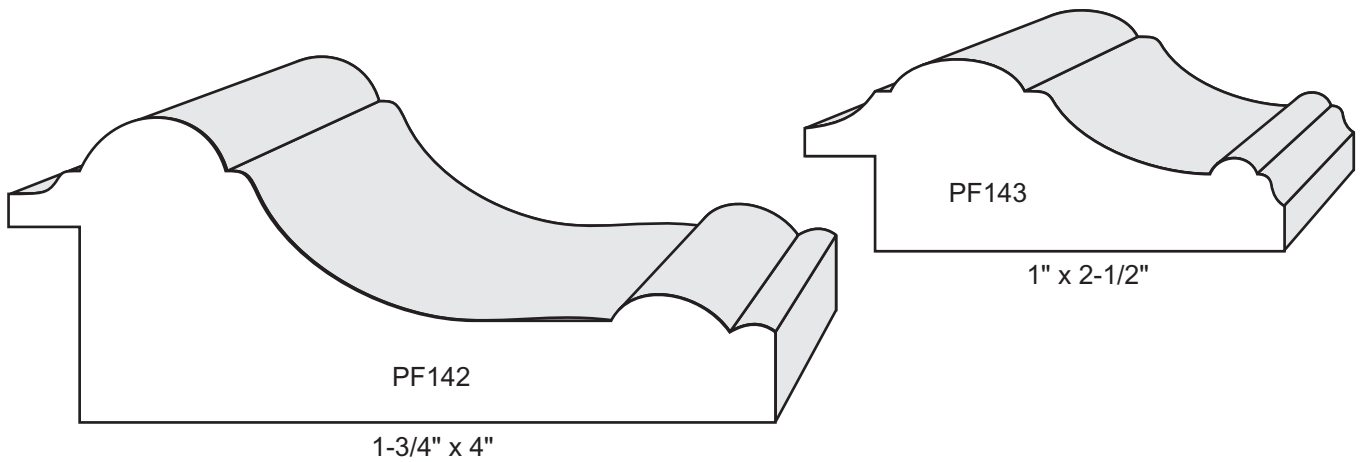

Woodmaster Picture Frame Patterns

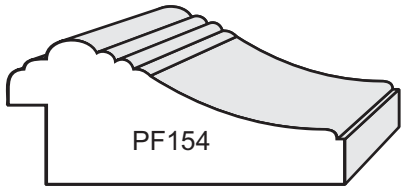

PF154

3/4" x 1-3/4"

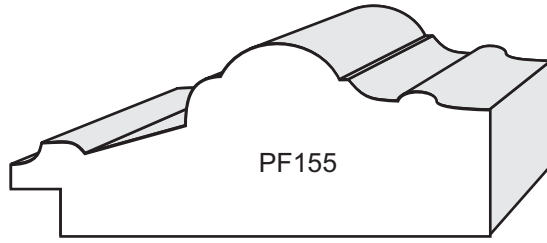

PF155

1" x 2-1/2"

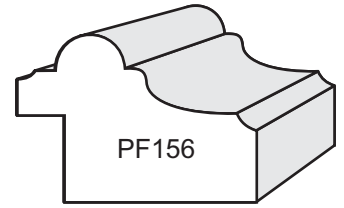

PF156

7/8" x 1-1/4"

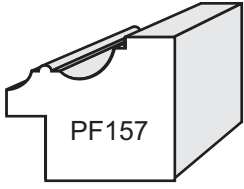

PF157

3/4" x 7/8"

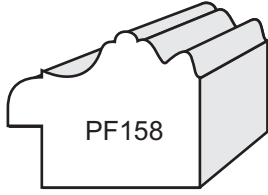

PF158

13/16" x 1"

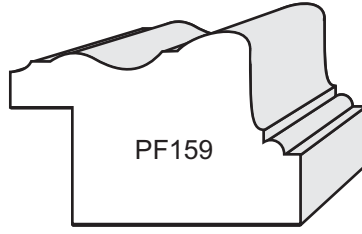

PF159

1" x 1-1/2"

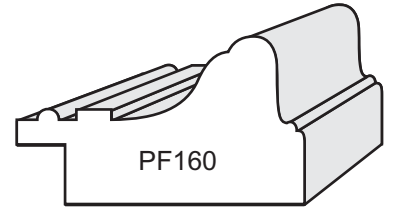

PF160

7/8" x 1-1/2"

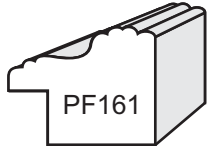

PF161

5/8" x 3/4"



PF162

3/4" x 1-1/4"

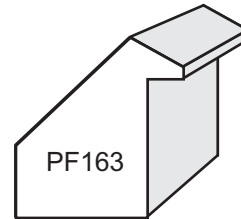

PF163

15/16" x 7/8"

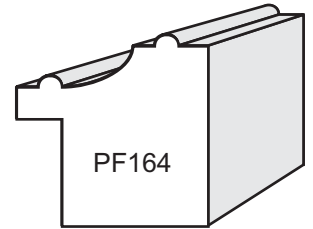

PF164

1" x 1"

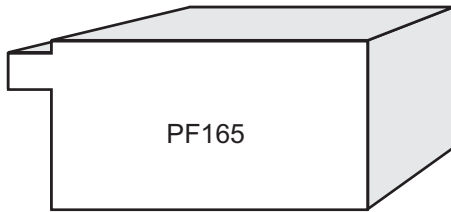

PF165

7/8" x 1-7/8"

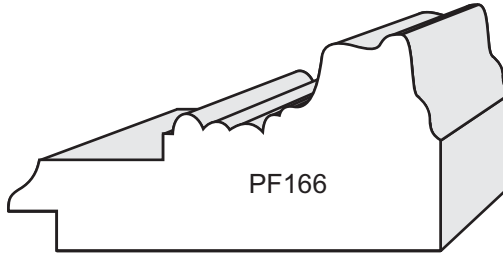

PF166

1-1/8" x 2-1/4"

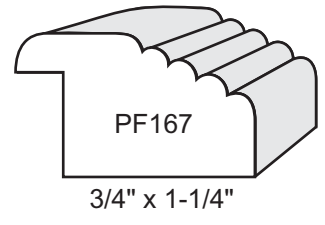

PF167

3/4" x 1-1/4"

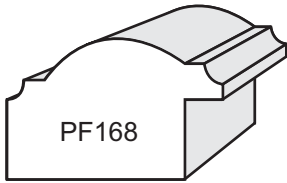

PF168

3/4" x 1-1/8"

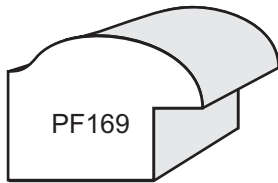

PF169

3/4" x 1"

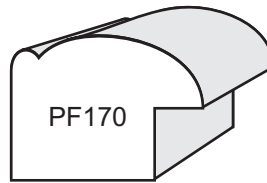

PF170

3/4" x 1"

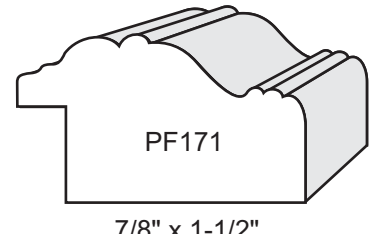

PF171

7/8" x 1-1/2"

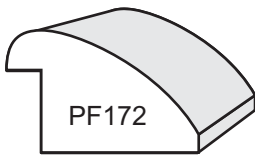

PF172

5/8" x 1"

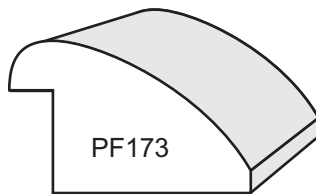

PF173

13/16" x 1-1/4"

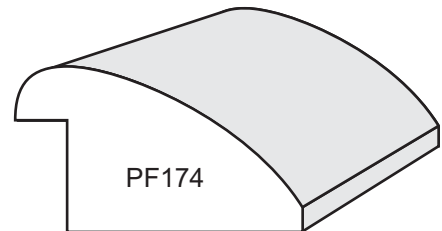

PF174

7/8" x 1-1/2"

Woodmaster Picture Frame Patterns

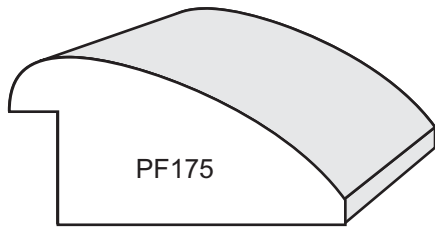

PF175

7/8" x 1-3/4"

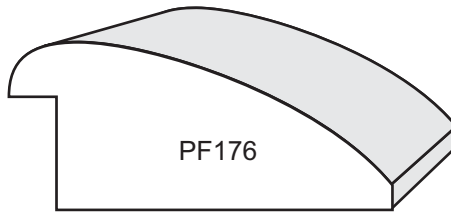

PF176

7/8" x 2

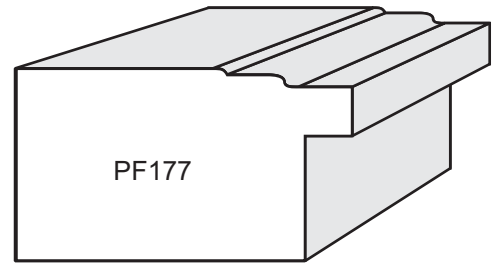

PF177

1" x 1-3/4"

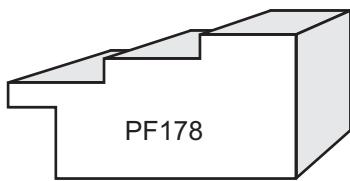

PF178

3/4" x 1-1/2"

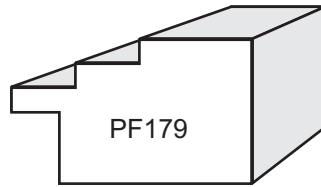

PF179

3/4" x 1-1/4"

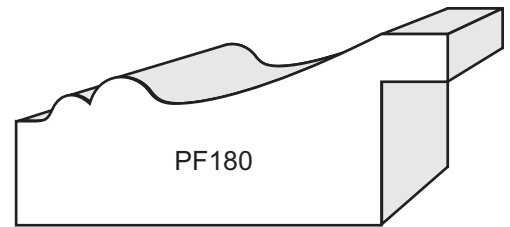

PF180

1" x 2-1/4"

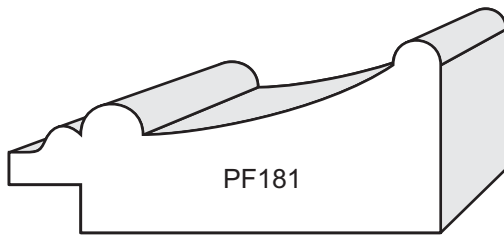

PF181

1" x 2-1/4"

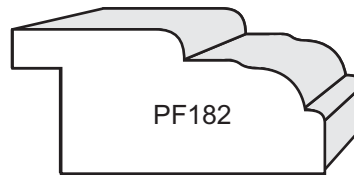

PF182

1-3/4" x 1-5/8"

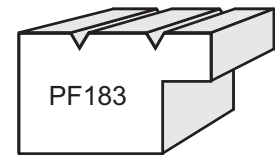

PF183

5/8" x 1"

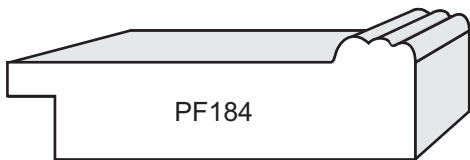

PF184

5/8" x 1-1/8"

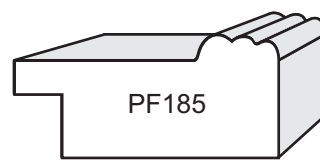

PF185

5/8" x 1-3/8"

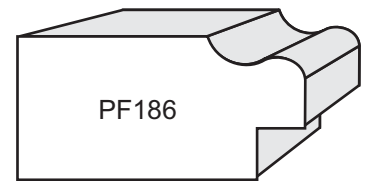

PF186

3/4" x 1-1/2"

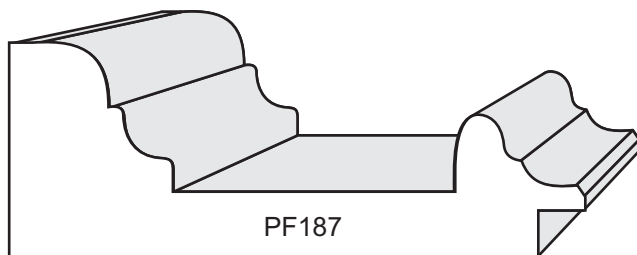

PF187

1-1/8" x 3"

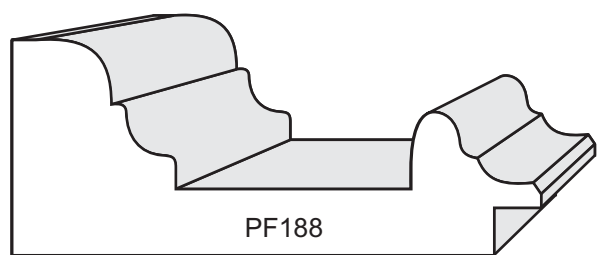

PF188

1-1/8" x 2-3/4"

Woodmaster Picture Frame Patterns

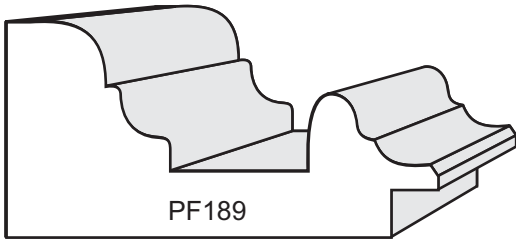

PF189

1-1/8" x 2-1/4"

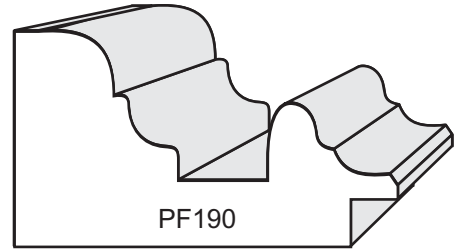

PF190

1-1/8" x 2"

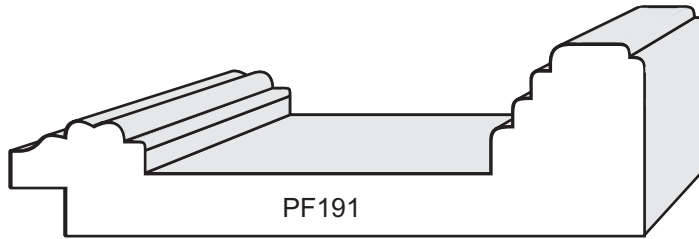

PF191

1" x 3-1/4"

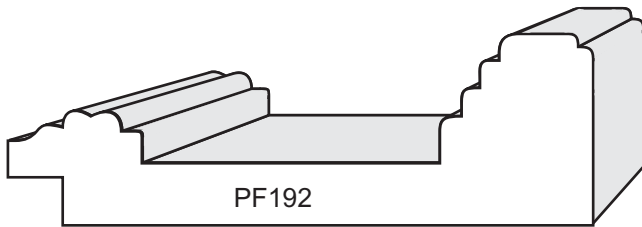

PF192

1" x 3"

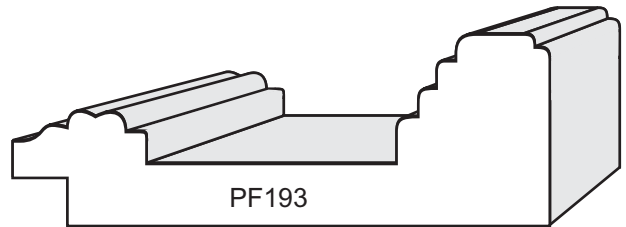

PF193

1" x 2-3/4"

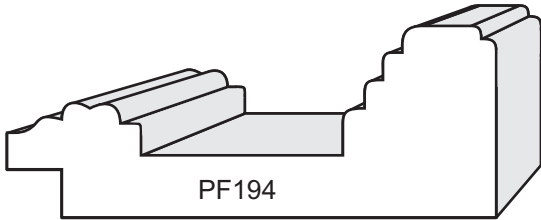

PF194

1" x 2-1/2"

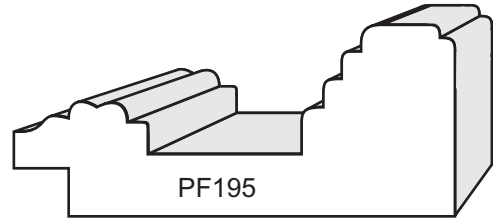

PF195

1" x 2-1/4"

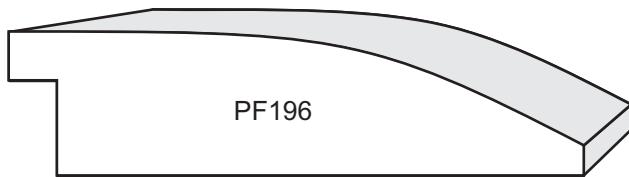

PF196

3/4" x 3"

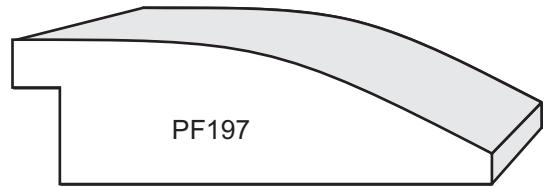

PF197

3/4" x 2-1/2"

Woodmaster Picture Frame Patterns

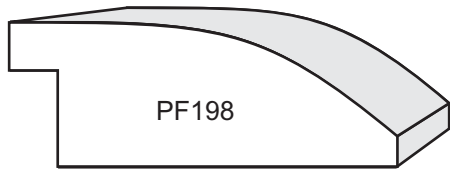

PF198

3/4" x 2"

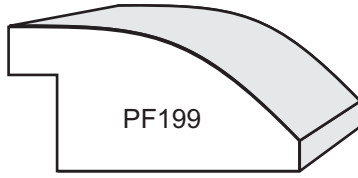

PF199

3/4" x 1-1/2"

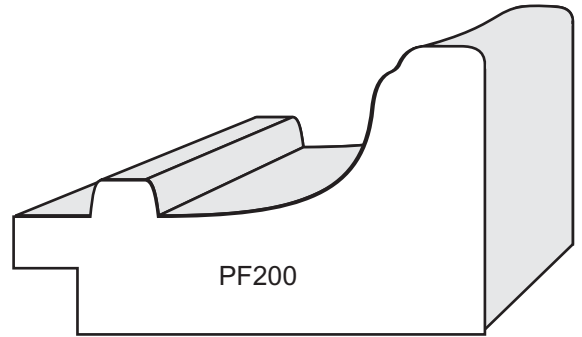

PF200

1-1/2" x 2-1/2"

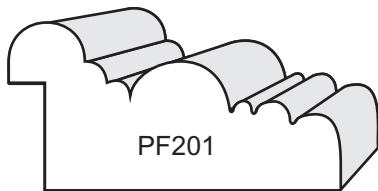

PF201

7/8" x 1-3/4"

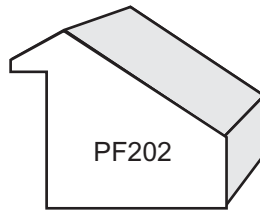

PF202

15/16" x 1-1/8"

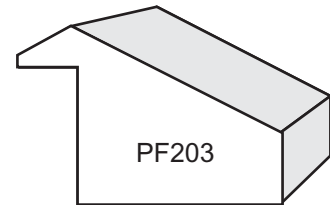

PF203

15/16" x 1-3/8"